



HiMaxX 60

SOUND REINFORCEMENT MONITOR

APPLICATIONS

- Live Sound P.A. System or Live Sound Monitor, D.J. System
- School & Corporate Audio Visual Sound Reinforcement
- Background Music/Announcement: Restaurants, Pubs
- Transportation Terminals, Clubs, Auditoriums, Theatres
- Gyms, Houses of Worship

FEATURES

- Lightweight Polypropylene Cabinet, 57,3 lbs
- Power Handling: 700W RMS @ 8 Ohms
- B&C custom designed 15" neodymium woofer with 3" voice coil
- B&C 1.4" compression driver with 2.5" voice coil
- Input Panel with 2 x Neutrik Speakon NL-4 jacks
- Multiple mounting options: "wall, ceiling, cluster, speaker stand, optional accessories required"
- Four M10 fly points
- Optional Carrying Bags available for protection for portable use
- High SPL capability: 131dB
- Asymmetrical profile allows use as a floor stage monitor
- Two ergonomic handles built in for easy carrying



Designed, Engineered
and Manufactured in ITALY

PRODUCT DESCRIPTION

The FBT HiMaxX 60 passive speaker features lightweight, yet rugged gas injected molded polypropylene cabinet construction. The asymmetrical shape of the HiMaxX 60 cabinet also allows use as a floor stage monitor. The HiMaxX 60 passive speaker is a two way design incorporating a custom B&C 15" low frequency woofer 3" voice coil with a neodymium magnet structure, die cast aluminum frame and a B&C 2,5" voice coil compression driver coupled to a 90°H x 60°V horn with a 1,4" exit. The internal passive crossover filter featuring "soft-trip" circuitry to ensure full protection of LF woofer and HF driver. With a frequency range of 40Hz-20kHz, the HiMaxX 60 provides hi fidelity sound for both speech and music applications with a maximum SPL of 131dB. A front face steel grille protects the woofer from external damage. The rear input panel features 2 Neutrik NL-4 Speakon inputs to allow daisy chaining an additional HiMaxX 60 speaker. The four M10 fly points built into the cabinet, along with the optional Box 104 or Box 105 mounting brackets allow the HiMaxX 60 speakers to be surface mounted on walls or ceilings. A standard 1,38" speaker stand socket allows the HiMaxX 60 to be mounted on speaker stands.

ELECTRICAL PERFORMANCE

System Type:	2 Way
Recommended Amplifier	700W RMS
Long Term Applicable Power (AES)	350W
Short Term Applicable Power (IEC 268-5)	1400W
Nominal Impedance	8 Ohm
Frequency Response @ -6dB	40Hz - 20kHz
Sensitivity @ 1W, 1m	99 dB
Maximum SPL (continuous/peak)*	128dB / 131dB
Dispersion	90°H x 60°V
Crossover Frequency	1,3 kHz
Recommended HP Filter	35 Hz - 24 dB oct.

PHYSICAL

Low Frequency Woofer	1x15" / 3" Coil
High Frequency Driver	1,4" - 2,5" Coil
Input Connectors	2 x Speakon NL4
Net Dimensions (WxHxD)	19" x 29,8" x 16,8"
Shipping Dimensions (WxHxD)	20,4" x 34,1" x 23,6"
Net Weight	57,3 lbs
Shipping Weight	62,8 lbs
Enclosure Material	Polypropylene
Grille	Steel with powder coat black paint finish

* CONT. SPL: free space, based on RMS recommended amp rating and LF transducer average sensitivity data, 125mS time average
PEAK SPL: free space, based on short term applicable power rating and system peak sensitivity, 10mS time average



Hi MaxX 60

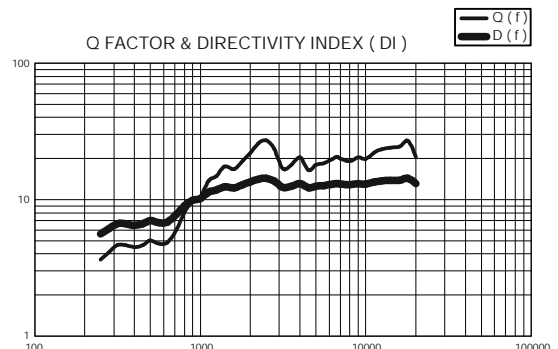
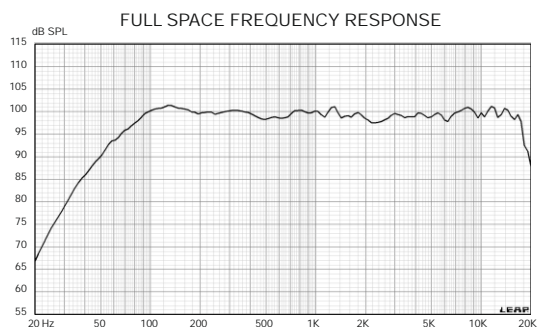
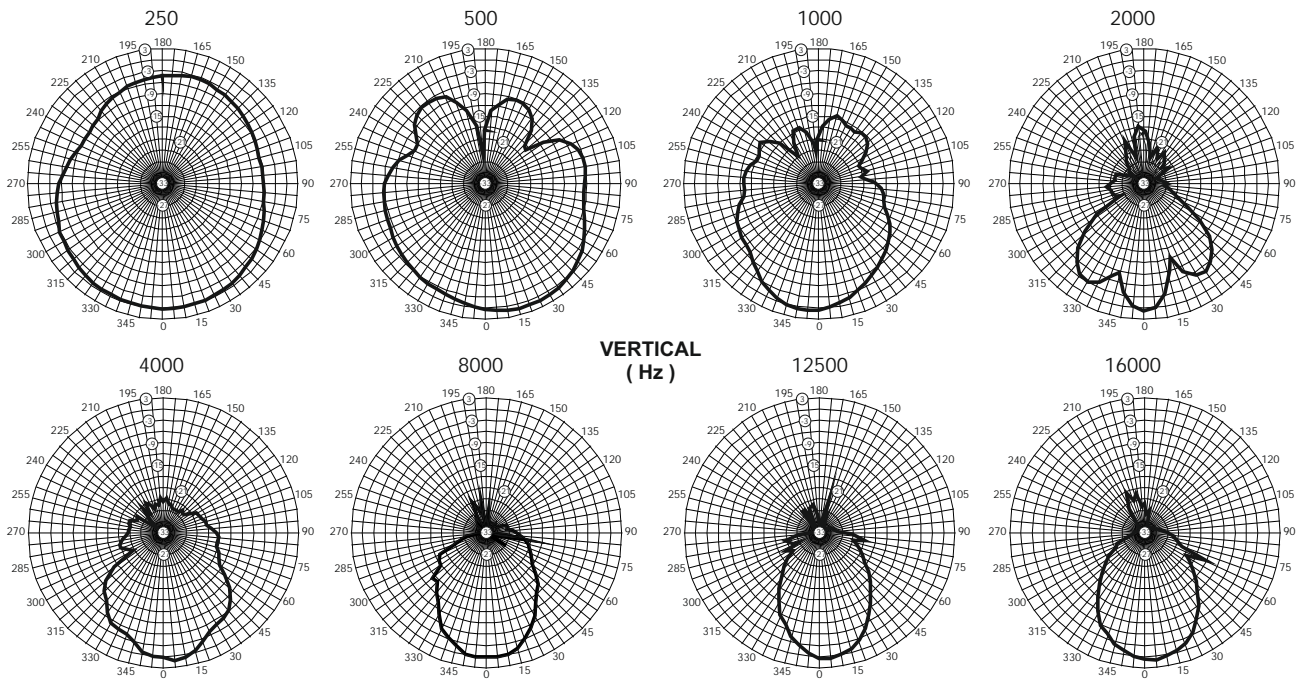
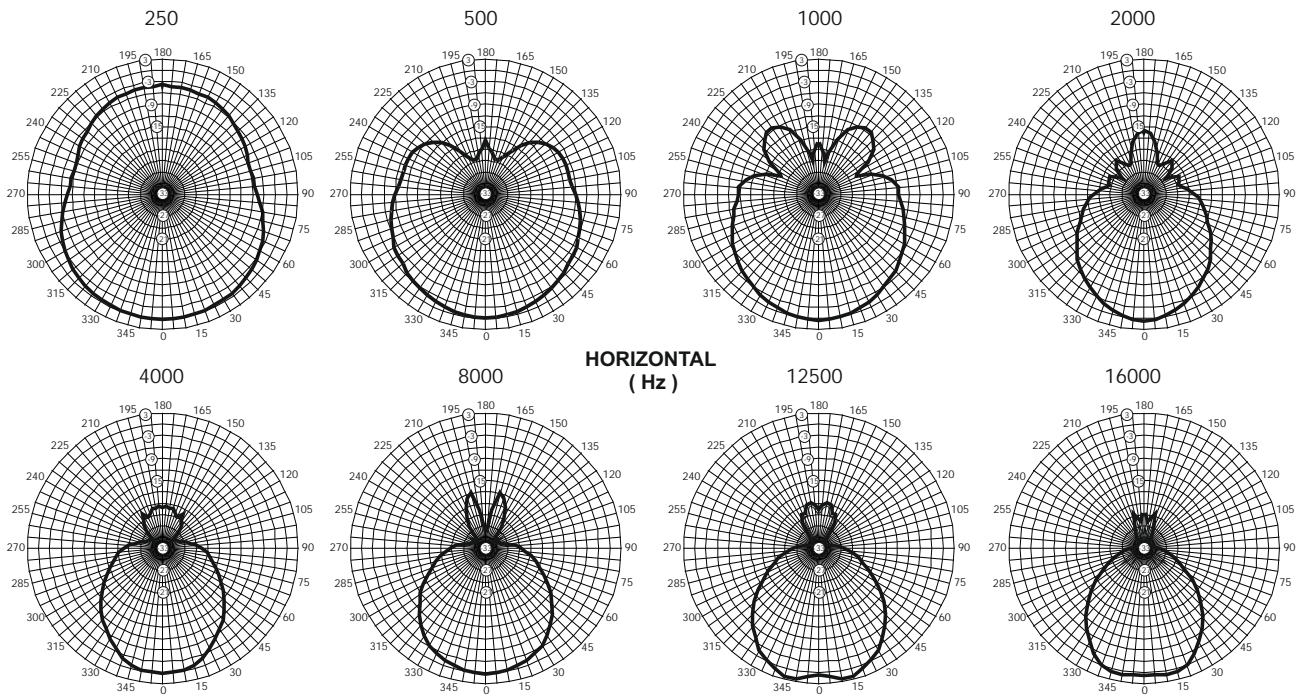



Hi MaxX 60

BLOCK DIAGRAM

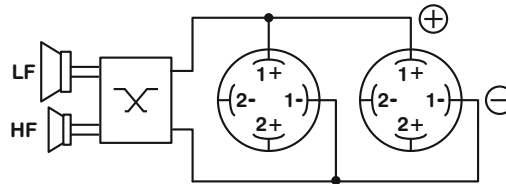

INPUT CONNECTORS

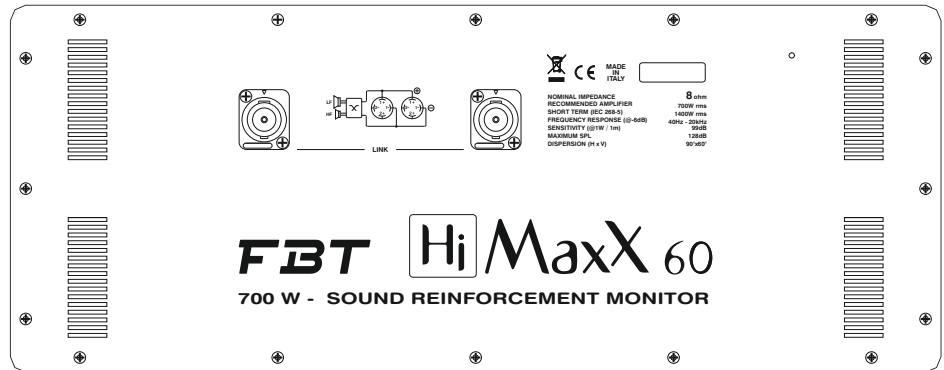

DIMENSION DRAWING

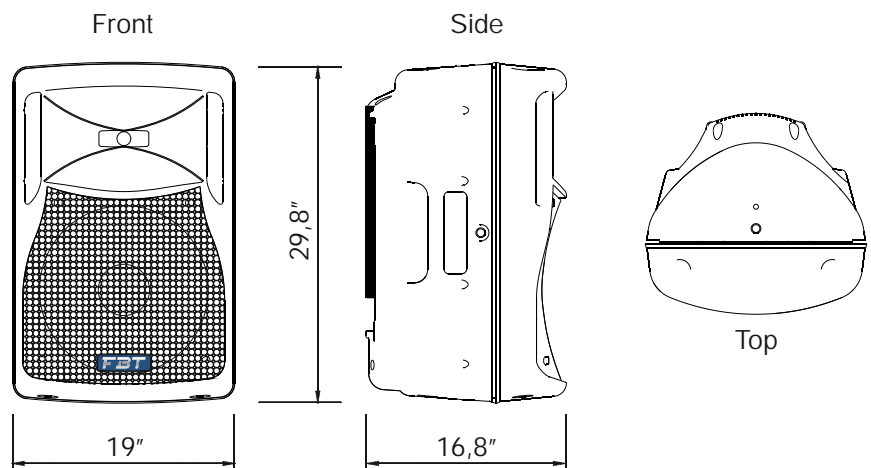

ACCESSORIES



BOX 104
Mount for
horizontal
wall installation



BOX 105
Mount for
vertical
wall installation

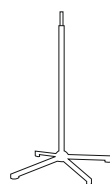
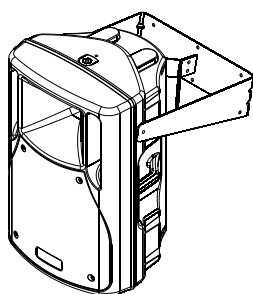
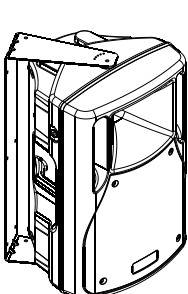

SS2
Standard speaker
floor stand



BOX 52BK
Adjustable for
sub-satellite
speaker connection,
with safety locking
device

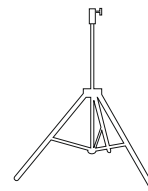

BOX 32BK
Adjustable aluminium
floor stand, damped
safety mechanism

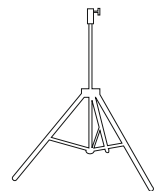

BOX 22BK
Adjustable aluminium
floor stand, ø1.38"
with ø1" adapter

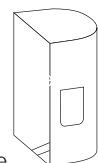

V33
Nylon case